

FOX MOBILE Inhalation System

Instructions for Use

Warning:

Read the entire instructions for use before operating the device. Correct and safe operation can only be achieved if instructions for use are followed. Store the instructions for use throughout the lifetime of the device.



Vectura Group Ltd

One Prospect West
Chippenham, Wiltshire, SN14 6FH
United Kingdom
www.vectura.com

Rx only

DAW-00045, Rev.09

Item Code 500045R9

USER ASSISTANCE INFORMATION

Please report any serious adverse event that has occurred in relation to the device to the manufacturer and to the Regulatory Authority of the country in which you are established.

Please use the following email address if you have technical problems or questions concerning the FOX MOBILE:

Email: fox.mobile@vectura.com

English: Instructions for Use

Table of Contents

1	Definitions	5
2	Safety Instructions	6
3	Indications for Use	7
4	Medication	7
5	Description of the Device	8
5.1	Package Content	8
5.2	Identification of Lights and Buttons	9
6	General Instructions	9
6.1	Charging the device	9
6.2	Assembly Instructions	11
6.3	Disassembly	12
6.4	Switching ON / OFF	13
6.5	Instructions for Cleaning and Maintenance	15
6.5.1	General	15
6.5.2	Cleaning	16
6.5.3	Dry the components	19
6.5.4	Disinfection	19
6.5.5	Storage and Transportation	20
7	Operating instructions	21
7.1	Fill the Nebulizer Reservoir	21
7.2	Inhalation	22
7.3	Setting the Inhalation Time	28
7.4	Wireless Connection	29
8	Troubleshooting	30
8.1	Error Messages	30
8.2	Hardware reset	34
9	Technical data	35
9.1	General	35
9.2	Aerosol characteristics	36
9.3	Accessories and Spare Parts	37
9.4	Service Life	38

9.5	Environmental Conditions	38
9.5.1	Environmental conditions for use	38
9.5.2	Environmental Conditions for Storage and Transport	39
9.6	Electrical Safety Information	39
9.7	Electromagnetic Compatibility	40
9.8	Recycling and Disposal	44
10	Instructions for Physicians on Inhalation time Selection	45
11	Warranty	47
12	Explanation of Symbols used	48

1 Definitions

The following definitions are used throughout this document. Please read these paragraphs carefully.



Warning:

Indicates a potentially hazardous situation which, if not avoided, could result in a life-threatening injury.

Caution:

Indicates a potentially hazardous situation which, if not avoided, may result in minor or moderate injury. This signal word may also be used to highlight unsafe practices or potential equipment damage.

2 Safety Instructions

Accurate knowledge of and compliance with these operating instructions is required before the FOX MOBILE is used. The operator of the FOX MOBILE is liable for its safe functioning in all cases when it is handled incorrectly. Vectura Group Ltd is not liable for any damage or malfunction resulting from incorrect use or from use for which the device is not intended.



Warning:

- Use the FOX MOBILE only for its intended use as described in these instructions for use.
- Use the FOX MOBILE only when prescribed by a physician and only with the medication prescribed for the FOX MOBILE. Always follow the dosage of your prescription.
- The use of other solutions, suspensions, emulsions and medications can lead to serious risks to health or can damage the device.
- The FOX MOBILE is designed for single patient use. Do not share your FOX MOBILE with other people.
- Do not leave children unattended during treatment. Always use close adult supervision when administering a treatment to a child.
- The FOX MOBILE is not designed for emergency and life supporting usage.
- Do not use the device if it is damaged. Do not modify the device.
- Keep the device away from small children and pets. This reduces the risk of strangulation (charger cable).
- Only use the charger delivered with the FOX MOBILE to avoid any damage, increased emissions or decreased immunity of the device.
- Ensure the FOX MOBILE has been properly cleaned before use, and is rinsed, cleaned and disinfected as per the instructions.
- The FOX MOBILE must not be used in the presence of medical gases or in oxygen enriched atmospheres.
- Do not use FOX MOBILE Base Unit and Inhalation Set for more than the specified service life in Section 9.4 to maintain consistent performance.

Caution:

- The FOX MOBILE needs special precautions regarding EMC (electromagnetic compatibility) and needs to be used according to the EMC information provided in section 9.7.
- The FOX MOBILE may be affected by portable or mobile RF (radio frequency) communication equipment. In case of malfunction increase distance to portable or mobile RF communication equipment. Detailed information is provided in the section 9.7.
- Federal (US) law restricts this device to sale by or on the order of a physician.

3 Indications for Use

The FOX MOBILE inhalation system is a nebulizer system that will be used with patients for whom doctors have prescribed medication for nebulization in the home care, nursing home, sub-acute institution or hospital environments. It is intended for patients 3 years and older who can coordinate breathing.

4 Medication

The FOX MOBILE Inhalation System is a nebulizer that shall be used only with the drug that was prescribed by a physician explicitly for this device. Do not use it for any other medication or substances.

5 Description of the Device

5.1 Package Content

The device package contains the following components:

- Instructions for Use
- FOX MOBILE Base Unit, battery powered
- FOX MOBILE Inhalation Set, containing Mouthpiece and Nebulizer Reservoir including Cap
- Charger, used for recharging the battery of the FOX MOBILE Base Unit
- Carry Case

Figure 1: Components of FOX MOBILE:

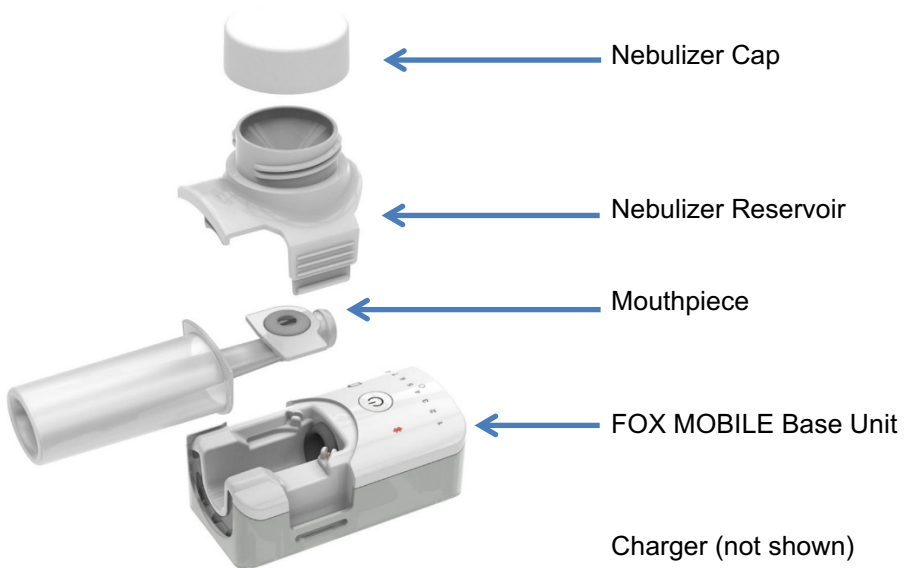

5.2 Identification of Lights and Buttons

Several LEDs indicate the status of the device:

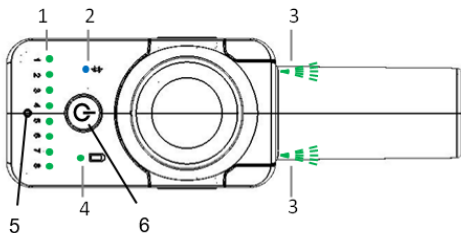

Figure 2: LED and button description:

- 1 Inhalation time LED
- 2 Wireless LED
- 3 Mouthpiece LED
- 4 Battery LED
- 5 Inhalation time button
- 6 On/Off button

6 General Instructions

6.1 Charging the device

Caution: The first use of the device must not be after the “First Use Before” date on the outer packaging.



Warning:

- Only use the charger delivered with your FOX MOBILE to avoid any damage, increased emissions, or decreased immunity of the device.
- Do not use an outlet, if the voltage on the outlet exceeds the specification on the charger. When travelling, use a suitable power socket adapter.
- Unpack all components of the Inhalation System packaging and charge the Base Unit completely before first use.



- Connect the Charger cable to the FOX MOBILE Base Unit.
- Plug the Charger into a suitable socket outlet.

- During charging, the Power LED flashes green. The FOX MOBILE is fully charged when the Power LED is permanently green.
- After the device is fully charged, unplug the Charger from the socket outlet. Disconnect the Charger from the FOX MOBILE Base Unit.





Note: If the battery of your FOX MOBILE is completely flat, it will require a minimum of 15 minutes charging in order to complete a treatment.

Check the battery status of your FOX MOBILE before use. If the battery is running low, an orange light will flash at the end of treatment.

Caution:

When the Power LED is orange, FOX MOBILE should be charged within the next day. When it is flashing orange, it needs to be charged before the next treatment. Please note that you cannot take a treatment while charging.

The following table shows the different Power LEDs and Mouthpiece LEDs while charging:

Name	Colour	Indication
Power LED		Green: Fully charged, disconnect charger
		Green flashing: Charging
		Orange constant: Charge within the next day
		Orange flashing: Charge before next treatment
Mouthpiece LED while charging		Orange constant or flashing: Warning – Device is turned on whilst charging. Note: Treatment is not possible whilst charger is connected

6.2 Assembly Instructions

Assemble the FOX MOBILE as shown in the following illustrations. Ensure that the individual parts, especially the Nebulizer Reservoir, are not damaged.

- Attach the Mouthpiece to the FOX MOBILE Base Unit. The mouthpiece must be latched into the base unit.

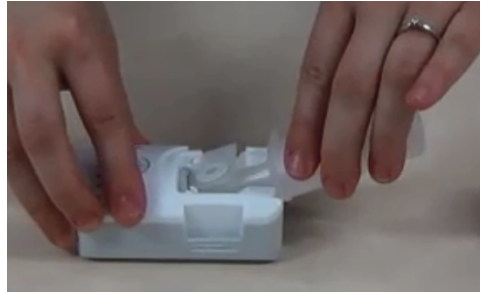

Caution: Do not touch the metal parts (membrane), as it may be damaged easily

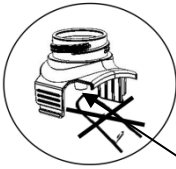

Membrane

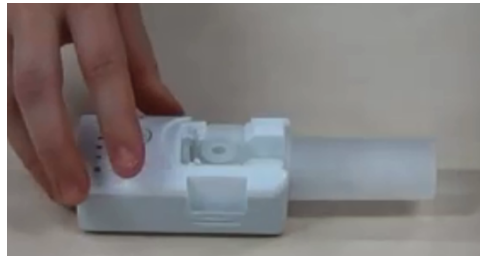

- Attach the Nebulizer Reservoir to the Base Unit. Ensure the arms are clipped in place on both sides.



- Fully assembled device.



6.3 Disassembly

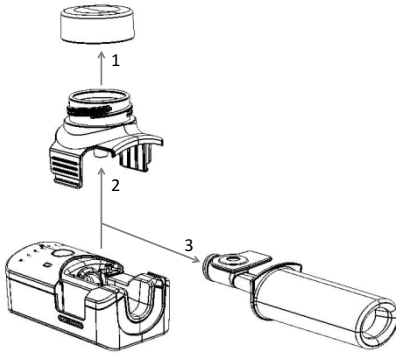



Figure 3: Disassembly instructions:
1. Remove the Nebulizer Reservoir
2. Remove the Mouthpiece

 **Warning:** Do not disassemble the FOX MOBILE Base Unit.

Caution: The FOX MOBILE Base Unit must not become wet. Water inside the Base Unit can seriously affect its performance.

6.4 Switching ON / OFF

- If connected, disconnect the Charger from the FOX MOBILE Base Unit.



- Press the On/Off key.

- Wait for the device to perform the auto-test. All LEDs are illuminated during the auto-test.











- The auto-test is finished when only the power LED is illuminated. The FOX MOBILE clicks twice at the end of the auto-test.

Caution: Do not inhale during auto-test.

Caution: If the Mouthpiece LED flashes orange 🚫 and the base unit beeps, refer to section 8.

- Keep the On/Off key pressed for 2 seconds to switch the FOX MOBILE off.

The following table shows the different light modes while switching ON/OFF the device:

Name	Colour	Indication
Inhalation time LED		Green: Device is switched ON.
		Green flashing (once): Device performing auto-test and the selected treatment time is showing
Power LED		Green: Device performing auto-test and it is fully charged
		Constant orange: Device performing auto-test and needs to be charged on the next day
		Flashing orange: Device performing auto-test and needs to be charged before the next treatment
Mouthpiece LED		Green flashing (once): Device switched ON
		Green permanent: Device performing auto-test
Wireless Connection LED		Blue: Device performing auto-test

6.5 Instructions for Cleaning and Maintenance

6.5.1 General

To avoid risks to health from a contaminated device, it is essential to comply with the following hygiene rules:

- Only use a device which has been cleaned according to the section 6.5.2 Cleaning.
- Replace the FOX MOBILE Inhalation Set after service life is completed. Refer to section 9.4.



Warning: Ensure adequate drying after cleaning. Condensation or residual moisture can present an increased risk of bacterial growth.

Caution:

- Please check the parts of your nebulizer regularly and replace any defective (broken, deformed or discolored) parts.
- If several medications are to be inhaled in turn within the scope of inhalation treatment, remove the remaining medication solution from the nebulizer and rinse it briefly with distilled water.



Figure 4: Parts which require cleaning: Nebulizer Cap, Nebulizer Reservoir and Mouthpiece.

6.5.2 Cleaning

Follow the instructions below to clean and disinfect the device.

Base Unit Cleaning:

- To clean the FOX MOBILE Base Unit, wipe the exterior of the housing with a damp cloth or a disinfecting cloth.



Warning: Do not disassemble the FOX MOBILE Base Unit.



Warning:

- Do not use a dish washer or sterilizer to clean or disinfect the Inhalation Set.
- Use standard washing-up liquid (for manual washing-up) without disinfection properties and without skincare additives (e.g. balsam).
- Use the recommended dilution as specified by the manufacturer of the washing-up liquid.
- Use of other cleaning detergents may damage the device (e.g. disinfectants, detergents with skin care additives and detergents to be used in dishwashers).
- Do not use any methods for cleaning or disinfection other than those described here.

Inhalation Set Cleaning - Step 1: Rinse immediately after use. Disassemble the Nebulizer Reservoir, Nebulizer Cap and Mouthpiece from the device. Remove visible dirt. Rinse the Nebulizer Reservoir, Nebulizer Cap and Mouthpiece with distilled water for minimum 20 seconds. When rinsing the Nebulizer Reservoir make sure that all remaining medication is removed.

Inhalation Set Cleaning - Step 2: Full Cleaning Procedure for Inhalation Set immediately after rinsing:

- Fill a clean bowl with 0.5 liters of distilled water. Add 5 drops of manual washing-up liquid.



- Place the disassembled Nebulizer Reservoir, Nebulizer Cap and Mouthpiece into the cleaning solution. The components need to be fully submerged. The opening of the Nebulizer Reservoir needs to face upwards. Make sure that the components do not touch the membrane.



- Leave the components in the solution for a minimum of five minutes and agitate gently. If necessary, use a soft dish cloth and wipe carefully the Mouthpiece, Nebulizer Cap and Nebulizer Reservoir with exception of the membrane.



- After cleaning with detergent rinse all components intensively with distilled water for at least one minute. Pay attention that the inside of the Nebulizer Reservoir, Nebulizer Cap and Mouthpiece is rinsed intensively.

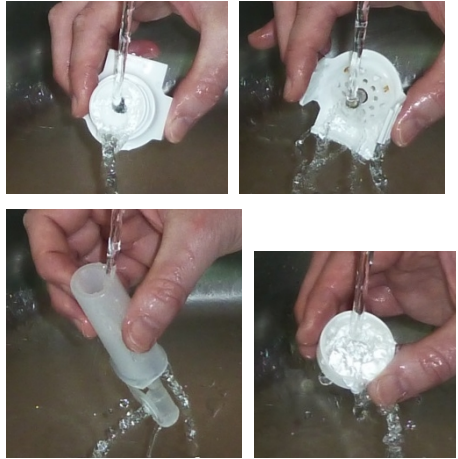

- Shake all components thoroughly to remove excess water, paying attention to areas where moisture may be trapped.
- The cleaning procedure is complete. After you have cleaned the components, continue with drying. Please refer to chapter 6.5.3 Dry the components.

Caution:

- Do not touch the membrane or try to clean it with a brush or any other object, as it can be easily damaged.
- Do not use tap water as any calcification can damage the Nebulizer Reservoir and reduce its service life.
- The FOX MOBILE Base Unit must not become wet. Water inside the Base Unit can seriously affect its performance.
- Ensure FOX MOBILE Inhalation Set is rinsed immediately after each use.

6.5.3 Dry the components

To dry the Nebulizer Reservoir, Nebulizer Cap and Mouthpiece follow these steps:

- To remove left-over water, gently shake the Nebulizer Reservoir, Nebulizer Cap and Mouthpiece.
- Tap the front end of the Mouthpiece carefully on a clean, dry and lint-free paper towel to remove left-over water.
- Press the back end of the Mouthpiece carefully on a clean, dry and lint-free paper towel to remove left-over water from the filter.

- Put the Nebulizer Reservoir, Nebulizer Cap and Mouthpiece on a clean, dry and lint-free paper towel.
- Let the components dry adequately overnight, if possible.

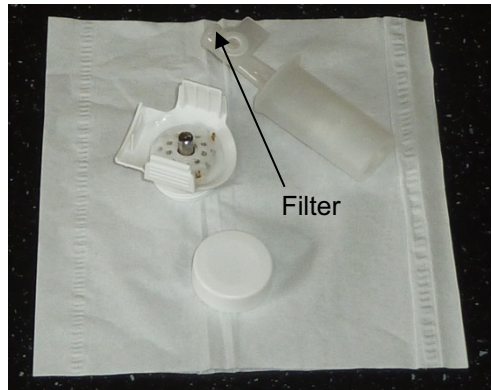

Your device is now ready for the next treatment or for storage and transportation. For more details on how to store or transport the FOX MOBILE read chapter 6.5.5.

All components must be dry after rinsing, cleaning and disinfection.

6.5.4 Disinfection

Caution: Do not attempt to disinfect the Base Unit.

Disinfect the Nebulizer Reservoir and Mouthpiece after 7 days of use or 21 treatments whichever comes first. Do not disinfect the Nebulizer Reservoir and Mouthpiece more than once during its service life. Refer to section 9.4 for details.

The components should be cleaned after every use and before disinfection. Refer to section 6.5.2 for detail on how to clean FOX MOBILE.

Caution:

- Do not boil for longer than 10 minutes to prevent damage to the Nebulizer Reservoir and mouthpiece.

- Do not use tap water as any calcification can damage the Nebulizer Reservoir and reduce its service life.

In order to disinfect the Nebulizer Reservoir and Mouthpiece, complete the following steps:

- Fill a pan with distilled water at room temperature.
- Place the Nebulizer Reservoir, Nebulizer Cap and Mouthpiece in the pan, ensuring they are fully submerged.
- Put the pan on the stove.
- Turn on the heat and allow the water to reach boiling point with the components in it.
- Boil the distilled water with the Nebulizer Reservoir and Mouthpiece for 10 minutes.
- Turn off the heat.
- Place the pan on a heat-proof surface.
- Use tongs to remove the components from the pan.
- Place hot components on a clean, dry, lint-free paper towel.
- Let the components cool down for 10 minutes.

Caution: Do not touch the hot components or boiling water. As this can lead to serious scalds.

After disinfection is complete, allow the components to dry. Refer to section 6.5.3 for detail on how to dry the Nebulizer Reservoir.

6.5.5 Storage and Transportation

The FOX MOBILE Inhalation Set must be cleaned and dried before storage (refer to section 6.5.2).

For storage and transportation:

- Store and transport the Base Unit, Nebulizer Reservoir, Nebulizer Cap and Mouthpiece in the carry case.
- Store the carry case with the components in a dry and dust-free environment.
- Do not store the carry case with the components in direct sunlight.

Store and transport the components within the temperature range described in section 9.5.2.

7 Operating instructions

7.1 Fill the Nebulizer Reservoir

Before every treatment, check that the FOX MOBILE is correctly assembled and the air inlet slots at the back of the FOX MOBILE Base Unit are not blocked.

- Disconnect the Charger from the FOX MOBILE Base Unit.



- Assemble the device according to section 6.2.



- Remove the Nebulizer Cap.



- Fill the Nebulizer Reservoir with the quantity of medication prescribed by your physician.



- Close the Nebulizer Cap.

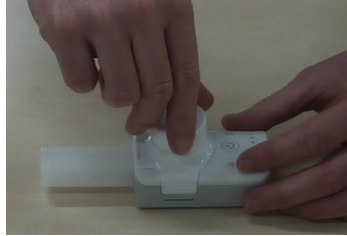

- Continue with the Inhalation immediately.

Caution:

Please ensure that the medication level is below the rim at the top of the Nebulizer Reservoir. If it has been overfilled, discard the complete filled medication and clean the nebulizer (see section 6.5). Once clean and dry, re-start the filling steps.

7.2 Inhalation

The device will guide you to achieve an optimal inhalation flow rate to achieve good lung deposition, via the lights in the mouthpiece.

Note: LEDs will appear more obviously when the device is used out of direct sunlight.

In order to start your treatment:

- Switch the device on.

Caution:

While switching on the device, the Mouthpiece shall not be placed in the mouth. The Mouthpiece shall not be blocked.

- Sit in a relaxed and upright position.
- Place the mouthpiece between your teeth and enclose the mouthpiece with your lips.

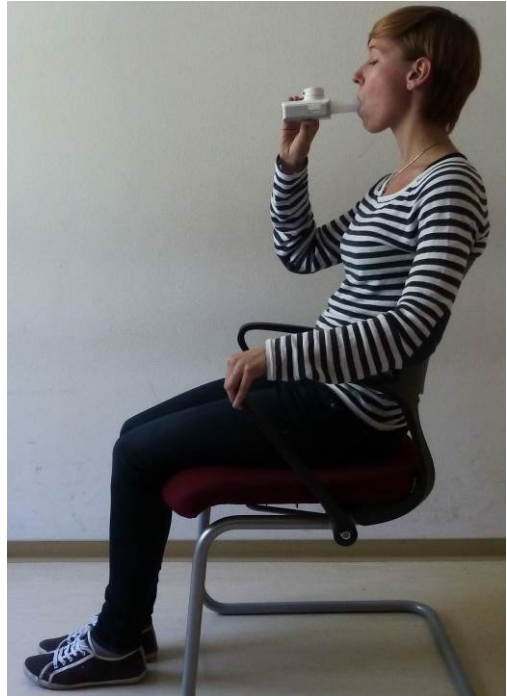

Caution:

Keep the device horizontal during inhalation.





- Inhale slowly through the Mouthpiece and watch the Mouthpiece LED:
- Green lower brightness: Incorrect inhalation speed, try to inhale faster or more slowly. Full brightness indicates the optimum inhalation speed



- Green full brightness: Optimum inhalation speed



- When you have reached the end of the chosen inhalation time, the air channel will close (with a clicking sound). Inhale until you feel the inhalation channel has closed.
- Note: If you cannot comfortably reach the end of the inhalation time when the air channel closes, you should consider reducing the inhalation time setting, as described in section 7.3. If you can comfortably reach the end of your inhalation time, you can consider extending your inhalation time setting.
- Remove the Mouthpiece from your mouth and exhale. You may also exhale through your nose.



 **Warning:** Do NOT exhale into the mouthpiece. Hold the device away from your mouth before exhaling.

- Orange flashing: If the mouthpiece flashes orange, you have inhaled longer or shorter than intended. Refer to troubleshooting section 8.



- Green flashing (5 seconds): End of treatment.



- You can pause for breath between inhalations, if necessary. The FOX MOBILE will stay active for 5 minutes and you can continue your inhalation at any time during this time period. Try not to pause longer than 5 minutes between inhalations. In case the FOX MOBILE has switched off, press the ON/OFF key to continue the inhalation session.
- Continue with inhalation until the device is flashing slowly green to indicate that the treatment has finished.
- The FOX MOBILE switches off automatically at the end of the treatment.
- Proceed with section 6.5.

General advice during treatment:

- Place the Mouthpiece between your teeth and enclose it completely with your lips.
- Do not block the Mouthpiece with your tongue during inhalation.
- Make sure that aerosol does not escape through your nose and do not inhale additional air through your nose during inhalation. If necessary, use a nose clamp.

7.3 Setting the Inhalation Time

The inhalation time can be adjusted in 0.5 seconds intervals between 1 second and 8 seconds. For the first use of the device set the inhalation time defined by your attending physician.

To change the inhalation time, use the tip of a pen as shown in Figure 5 and increase the inhalation time by 0.5 seconds. The eight inhalation time LEDs show the set inhalation time.



Figure 5: Use the tip of a pen to change the inhalation time.



Figure 6: Example setting with an inhalation time of 3.5 seconds.

Whole second intervals are indicated by one light over one digit and half second intervals are indicated by two lights over two digits, as represented in Figure 6 where digits 3 and 4 are indicated, meaning that the inhalation time is set to 3.5 seconds.

Reduce the inhalation time if:

- You stop inhaling and then hear the device “click” and the mouthpiece flashes orange, you have inhaled for a shorter duration than intended.

Note: The inhalation time will always increase towards the 8 second setting, before returning back and beginning again at 1 second.

Increase the Inhalation time if:

- You realize that you could easily inhale for a longer time, or
- If you hear the device “click” and the mouthpiece flashes orange while you are still inhaling, you have inhaled longer than intended.

Note: The adjusted inhalation time is stored even when you turn the device On/Off and this setting will be used on your next treatment.

7.4 Wireless Connection



Note: FOX MOBILE has the capability to connect to an App via Wireless Connection, however that feature is currently not available.

Should the Wireless Connection light illuminate, refer to section 8 for troubleshooting.



8 Troubleshooting

8.1 Error Messages

Error messages are related to different light modes. Refer to sections 6.1, 6.4 and 7.2 for the different light modes.

Error	Possible Causes and Solution
General	
<p>Power LED is continuously orange</p> 	<ul style="list-style-type: none"> • Low battery power: Charge the device after next treatment. • When the Power LED is orange, the FOX MOBILE should be charged within the next day. See section 6.1 for charging instructions.
<p>Power LED is flashing orange</p> 	<ul style="list-style-type: none"> • Very low battery power: Charge the device before taking a treatment. See section 6.1 for charging instructions.
<p>Device cannot be switched on. No LEDs light up.</p>	<ul style="list-style-type: none"> • Battery is fully depleted: Charge the device before taking a treatment see section 6.1 for charging instructions. • If battery does not recover and error still remains, contact support.

Error	Possible Causes and Solution
<p>The device does not trigger and does not respond to keys.</p>	<ul style="list-style-type: none"> • Make sure the device is charged. See section 6.1 for charging instructions. • Reset the device (section 8.2) • Device error: Contact support.
<p>Mouthpiece LED is flashing orange and all inhalation time LEDs are illuminated. Device shuts off after showing the error.</p>	<ul style="list-style-type: none"> • Ensure that the device is used within the allowed temperature range (refer to chapter 9.5.1 Environmental Conditions for use). Allow a few minutes for the device to acclimatize, when transferring from hot or cold conditions. • Contact support if the error persists.
After switching on	
<p>The device beeps, the Mouthpiece LED is flashing orange and the device shuts off.</p> 	<ul style="list-style-type: none"> • Check whether the Nebulizer Reservoir is properly connected to the device. If it is not properly connected, connect it according to section 6.2 and restart the device. • Check whether the Nebulizer Reservoir is filled. If it is empty (and you have not just completed a treatment), fill the Nebulizer Reservoir according to instructions in section 7.1 and restart the device. <p>Note: when you restart your device an auto-test will be repeated. Do not try to inhale during the auto-test.</p>
<p>The Mouthpiece LED turns orange and the device changes into charging mode.</p>	<ul style="list-style-type: none"> • Disconnect Charger. <p>Note: You cannot charge the device while taking a treatment.</p>
<p>It is not possible to change the inhalation time.</p>	<ul style="list-style-type: none"> • Reset the device (section 8.2) • Device error: Contact support.

Error	Possible Causes and Solution
<p data-bbox="90 217 309 245">During treatment</p> <p data-bbox="90 288 370 347">The Mouthpiece LED is flashing orange.</p> 	<ul data-bbox="426 288 1050 727" style="list-style-type: none"> • Release the Mouthpiece at exhalation phase as described in section 7.2. • Make sure that you do not try to exhale into the device at the end of an inhalation. • Make sure that you do not exhale into the device before starting an inhalation. • If the inhalation time of each single breath is too long or too short, please adjust the inhalation time according to instructions section 7.3, if permitted. • Make sure that the Nebulizer Reservoir and Mouthpiece are correctly attached.
<p data-bbox="90 767 370 826">The Mouthpiece LED is constant orange.</p> 	<ul data-bbox="426 767 958 826" style="list-style-type: none"> • Make sure that you do not inhale too fast according to instruction section 7.2
<p data-bbox="90 1023 370 1145">The Mouthpiece LED is constant orange and device switches into charging mode.</p>	<ul data-bbox="426 1023 1042 1114" style="list-style-type: none"> • During inhalation charging is not possible. Note: You cannot charge the device while taking a treatment.
<p data-bbox="90 1278 365 1369">Longer than usual treatment time. Drug in mouthpiece.</p>	<ul data-bbox="426 1230 1053 1414" style="list-style-type: none"> • Check whether the Nebulizer membrane at the Nebulizer Reservoir is damaged (i.e. the drug is leaking directly into the mouthpiece). Replace the Nebulizer Reservoir if necessary, and contact support if you do not have a replacement Nebulizer Reservoir.

Error	Possible Causes and Solution
Wireless Communication	
<p>The wireless connection LED is flashing quickly and the Mouthpiece LED is orange. The device turns off.</p>	<ul style="list-style-type: none"> • As described in section 7.4, FOX MOBILE has the capability to connect to an App via Wireless Connection, however that feature is currently not available. • If the Wireless Connection mode is ON, turn the device OFF and back ON again.

If after following these instructions the error persists, contact your clinic or study centre, who will contact Vectura at fox.mobile@vectura.com immediately.

8.2 Hardware reset

If the device does not respond to any key pressing, a hardware reset may be required. In order to do a hardware reset, press the “ON/OFF” key and the “inhalation time” key simultaneously. Use a pen to press the “inhalation time” key. The configuration of your FOX MOBILE is not changed. Make sure that the device is charged, a reset will not work if the battery is fully depleted.



Figure 7: Press the “ON/OFF” key and the “inhalation time” key simultaneously using a pen to press the “inhalation time” key.

The next time you turn your device ON the reset will take effect.

9 Technical data

9.1 General

The temperature in the nebulizing chamber will not rise more than 8°C (14.4°F) above ambient during normal use.

FOX MOBILE Base Unit

Minimum Fill:	0.1 ml
Maximum Fill:	4.0 ml
Inhalation Flow:	15 l/min
Weight:	0.128 kg (0.28 lb)
Dimensions (WxHxD):	154 x 55 x 51 mm (6.1 x 2.2 x 2.0 in)
Sound pressure level:	<80 dBA
Electrical Protective Class:	II Type BF
Charging interval:	weekly
FCC ID	QOQWT12
Ingress Protection:	IP22
	Solid particle protection: Protected against fingers or similar objects > 12.5 mm
	Liquid ingress protection: Protected against dripping water when tilted at 15°
Method of operation:	Breath actuated, triggered by a negative inhalation pressure of 3 mbar

Charger

To be used only for recharging the battery

Manufacturer:	XP Power LLC
Type:	VER05
Model:	VER05US050-UB
Power Input:	100 - 240 V / 50 – 60 Hz
Power Output:	5 VDC / 1000 mA

Charger (Alternative)

Manufacturer:	XP Power LLC
Type:	VFR05
Model:	VFR05US050-UB
Power Input:	100 - 240 V / 50 – 60 Hz
Power Output:	5 VDC / 1000 mA

Internal Battery

Type:	Secondary Battery
Chemistry:	Li-ion Polymer Battery
Capacity:	1350mAh

9.2 Aerosol characteristics

The following specifications were established via performance tests using a Next Generation Impactor (NGI) at a flow rate of 15 L/min equipped with a USP <601> induction port throat. Three device samples were tested with three runs each, for a total of nine sample points per each drug. Aerosol was sampled directly from the outlet.

One cycle is defined as nebulization until the device is empty, which are 60 to 70 breaths.

The specifications are listed below with intervals given for a 95% confidence level.

 **Warning:** The stated values may not be valid for medications with high viscosity or suspensions. In these cases, please gather information from the medication supplier. Aerosol data are available from Vectura upon request.

PARTICLE SPECIFICATION	SULTANOL	CROMO HEXAL	ATROVENT
Mass Median Aerosol Diameter (MMAD)	4.0 $\mu\text{m} \pm 0.1$	4.0 $\mu\text{m} \pm 0.1$	4.0 $\mu\text{m} \pm 0.1$
Geometric Standard Deviation (GSD)	1.7 ± 0.1	1.7 ± 0.1	1.7 ± 0.1
Total Emitted Dose (TED)	2.22 mg ± 0.08	17.75 mg ± 0.28	0.48 mg ± 0.01
Course Particle Fraction % (>4.7 μm)	37.0 ± 1.2	38.5 ± 2.02	37.2 ± 2.5
Fine Particle Fraction % (<4.7 μm)	63.0 ± 1.2	61.5 ± 2.02	62.8 ± 2.5
Respirable Particle Fraction % (<5.0 μm)	67.7 ± 1.1	66.2 ± 2.0	67.8 ± 2.4

9.3 Accessories and Spare Parts

DESCRIPTION	ITEM CODE
FOX MOBILE Inhalation Set (US)	08CD0007

FOX MOBILE cannot be connected to an anesthetic breathing system or a ventilator breathing system.

9.4 Service Life

The FOX MOBILE is intended for repeated use. The average life of the components is given in the following table.

COMPONENT	SERVICE LIFE
FOX MOBILE Base Unit	2 Years after 1 st use
FOX MOBILE Inhalation Set	A maximum of 14 days after 1 st use, or 42 treatments, whichever comes first.

The products can be reused when they are maintained according to the instructions for use and if they are undamaged. Vectura Group Ltd shall not be held liable for any damages or consequential damages, consequences for safety, reliability and performance of the device when using dirty or damaged components.

Replace the FOX MOBILE Inhalation Set after service life is completed. The components delivered with the FOX MOBILE Inhalation Set may be used for up to 42 cleaning cycles (after each treatment) and 1 disinfection. The FOX MOBILE Inhalation Set is intended for single patient use.

At the end of the service life, replacement is recommended to ensure hygienic and problem-free operation. In the event of visible damage or a noticeably longer nebulization time with the same substance and same quantity of medication, the Nebulizer Reservoir must be replaced immediately.

9.5 Environmental Conditions

9.5.1 Environmental conditions for use

Ambient conditions required for the use of the device:

- Ambient temperature: 5 to 35°C (41 to 95°F)
- Humidity range: 15 to 93% rH, non-condensing
- Ambient pressure: 700 hPa to 1060 hPa

In the event of extreme fluctuations of the ambient temperature, the system can malfunction due to condensation.

After transport or storage of the device at <0 °C (32°F) wait 30 minutes for temperature acclimatization.

9.5.2 Environmental Conditions for Storage and Transport

Ambient temperature during transport: -20 to 40°C (-4 to 104°F)

Caution:

If your device is left inside a closed vehicle temperature up to 80°C (176°F) can be reached. Do not expose your device to direct sunlight for extended periods of time (such as on the dashboard of a car).

- Ambient temperature during storage: -10 to 35°C (14 to 95°F)
(before first use or during longer periods on non-use)
- Relative humidity: 15 to 93% rH, non-condensing

9.6 Electrical Safety Information

Essential performance is defined according to IEC 60601-1 to be: performance necessary to achieve freedom from unacceptable RISK.

Considering the intended use of the device essential performance is not applicable to the FOX MOBILE Inhalation System.

9.7 Electromagnetic Compatibility

The FOX MOBILE complies with the electromagnetic compatibility standard, IEC 60601-1-2. The intended environment includes home healthcare and professional healthcare facilities. The device is not intended to be used in military areas, near HF surgical equipment and RF shielded rooms.



Warning:

- Electromagnetic interference can under certain conditions impair the device function. Interference can, for example, be caused by mobile telephones or other telecommunication equipment. If you detect such interference, switch off the device and increase the distance from possible sources of interference.
- The FOX MOBILE should not be used near to other equipment. If this is necessary, the FOX MOBILE should be checked to verify normal operation in the configuration in which it will be used.

Guidance and manufacturers` declaration – electromagnetic emission		
The FOX MOBILE is intended for use in the electromagnetic environment specified below. The customer or the user of the FOX MOBILE should assure that it is used in such an environment.		
Emissions test	Compliance	Electromagnetic environment - guidance
RF Radiated Emissions CISPR 11	Group 1 Class B	The FOX MOBILE uses RF energy only for its internal function. Therefore, its RF emissions are very low and are not likely to cause any interference in nearby electronic equipment.
RF Conducted Emissions CISPR 11	Group 1 Class B	The FOX MOBILE is suitable for use in all establishments, including domestic establishments and those directly connected to the public low-voltage power supply network that supplies buildings used for domestic purposes.
Harmonic emissions IEC 61000-3-2	Class A	
Voltage fluctuations / flicker emissions IEC 61000-3-3	Complies	

Guidance and manufacturers` declaration – electromagnetic performance			
The FOX MOBILE is intended for use in the electromagnetic environment specified below. The customer or the user of the FOX MOBILE should assure that it is used in such an environment.			
Immunity test	IEC 60601-1-2 Test Condition	Compliance level	Electromagnetic environment - guidance
Electrostatic discharge (ESD) IEC 61000-4-2	± 8 kV contact	± 8 kV contact	Floors should be wood, concrete or ceramic tile. If floors are covered with synthetic material, the relative humidity should be at least 30 %.
	± 15 kV air	± 15 kV air	
Radio-frequency EM fields and Proximity fields from RF wireless communications equipment IEC 61000-4-3	3 V/m 80 MHz – 2.7 GHz 80 % AM at 1 kHz	3 V/m 80 MHz – 2.7 GHz	Mains power quality should be that of a typical home healthcare or hospital environment.
	10 V/m 80 MHz – 2.7 GHz 80 % AM at 1 kHz	10 V/m 80 MHz – 2.7 GHz	
	27 V/m 380 - 390 MHz 50% PM at 18 Hz	27 V/m 380 - 390 MHz	
	28 V/m 430 - 470 MHz 50% PM at 18 Hz	28 V/m 430 - 470 MHz	
	9 V/m 704 - 787 MHz 50% PM at 217 Hz	9 V/m 704 - 787 MHz	
	28 V/m 800 - 960 MHz 50% PM at 18 Hz	28 V/m 800 - 960 MHz	
	28 V/m 1700 - 1990 MHz 50% PM at 217 Hz	28 V/m 1700 - 1990 MHz	
	28 V/m 2400 - 2570 MHz 50% PM at 217 Hz	28 V/m 2400 - 2570 MHz	
	9 V/m 5100 - 5800 MHz 50% PM at 217 Hz	9 V/m 5100 - 5800 MHz	
Power frequency (50/60 Hz) magnetic field IEC 61000-4-8	30 A/m	30 A/m	Power frequency magnetic fields should be at levels characteristic of a typical location in a typical commercial or hospital environment.

Guidance and manufacturers` declaration – electromagnetic performance

The FOX MOBILE is intended for use in the electromagnetic environment specified below. The customer or the user of the FOX MOBILE should assure that it is used in such an environment

Performance test	IEC 60601-1-2 Test Condition	Compliance Level	Electromagnetic Environment - Guidance
Conducted RF IEC 61000-4-6 Radio-frequency field IEC 61000-4-3	3 Vrms 150 kHz to 80 MHz	3 V	Portable and mobile RF communications equipment should be used no closer to any part of the FOX MOBILE, including cables, than the recommended separation distance calculated from the equation applicable to the frequency of the transmitter. Recommended separation distance $d = \frac{6}{E} \sqrt{P}$ where p is the maximum output power rating of the transmitter in watts (W) according to the transmitter manufacturer, E is the field strength in V/m and d is the recommended separation distance in metres (m). ^b Field strengths from fixed RF transmitters, as determined by an electromagnetic site survey ^a should be less than the compliance level in each frequency range. ^b Interference may occur in the vicinity of equipment marked with the following symbol: 
	6 Vrms ISM/amateur Bands	6V	

Guidance and manufacturers` declaration – electromagnetic performance

The FOX MOBILE is intended for use in the electromagnetic environment specified below. The customer or the user of the FOX MOBILE should assure that it is used in such an environment

Performance test	IEC 60601-1-2 Test Condition	Compliance level	Electromagnetic environment - guidance
Fast transient/ burst IEC 61000-4-4	± 2 kV for power supply lines	± 2 kV	Mains power quality should be that of a typical commercial or hospital environment.
Surge IEC 61000-4-5	± 1 kV line to line	± 1 kV differential mode	Mains power quality should be that of a typical commercial or hospital environment.
	± 2 kV Line to ground	± 2 kV common mode	
Voltage dips, short interruptions and voltage variations on power supply input lines IEC 61000-4-11	0 % U_T for 0,5 cycle At 0°, 45°, 90°, 135°, 180°, 225°, 270° and 315°	0,5 cycle	Mains power quality should be that of a typical commercial or hospital environment. If the user of the FOX MOBILE requires continued operation during power mains interruptions, it is recommended that the FOX MOBILE be powered from an uninterruptible power supply or a battery.
	0 % U_T for 1 cycle at 0°	1 cycle	
	70 % U_T for 25/30 cycles at 0°	25/30 cycles	
	0 % U_T for 250/300 cycles	250/300 cycles	

NOTE 1 At 80 MHz and 800 MHz, the higher frequency range applies.

NOTE 2 These guidelines may not apply in all situations. Electromagnetic is affected by absorption and reflection from structures, objectives and people.

NOTE U_T is the a. c. mains voltage prior to application of the test level.

^a Field strengths from fixed transmitters, such as base stations for radio (cellular/cordless) telephones and land mobile radios, amateur radio, AM and FM radio broadcast and TV broadcast cannot be predicted theoretically with accuracy. To assess the electromagnetic environment due to fixed RF transmitters, an electromagnetic site survey should be considered. If the measured field strength in the location in which the FOX MOBILE is used exceeds the applicable RF compliance level above, the FOX MOBILE should be observed to verify normal operation. If abnormal performance is observed, additional measures may be necessary, such as reorienting or relocating the FOX MOBILE.

^b Over the frequency range 150 kHz to 80 MHz, field strengths should be less than 3 V/m.

9.8 Recycling and Disposal

Refer to local regulations to dispose of the Base Unit after its service life. Used and cleaned hygiene articles of the Inhalation Set can be disposed in the normal household refuse.

Caution: Dispose of the Base Unit and the Inhalation Set after their service life.

10 Instructions for Physicians on Inhalation time Selection

The inhalation treatment with the FOX MOBILE is most efficient when the inhalation volume (or inhalation time per breath) is adjusted to the patient's lung function.

The inhalation volume can be selected either by Forced Expiratory Volume in 1 Second (FEV1) or by Inspiration Capacity (IC).

For selection according to FEV1 first select the appropriate column by the FEV1-value in % of the predicted value. Then select the line according to the FEV1-value in litres. In the last columns you get the recommended inhalation volume in litre and inhalation time per breath in seconds.

Severity Grade 1: FEV1% of predicted > 80% FEV1 in [l]	Severity Grade 2: FEV1% of predicted 50-80% FEV1 in [l]	Severity Grade 3: FEV1% of predicted 30-50% FEV1 in [l]	Severity Grade 4: FEV1% of predicted < 30% FEV1 in [l]	Inhalation time per breath [s]	Inspiration volume [l]
0.00 - 0.34	0.00 - 0.28	0.00 - 0.23	0.00 - 0.15	No setting available	
0.35 - 0.51	0.29 - 0.44	0.24 - 0.35	0.16 - 0.23	1.0	0.250
0.52 - 0.69	0.45 - 0.59	0.36 - 0.47	0.24 - 0.31	1.5	0.375
0.70 - 0.86	0.60 - 0.74	0.48 - 0.59	0.32 - 0.39	2.0	0.500
0.87 - 1.04	0.75 - 0.88	0.6 - 0.71	0.40 - 0.47	2.5	0.625
1.05 - 1.21	0.89 - 1.03	0.72 - 0.83	0.48 - 0.55	3.0	0.750
1.22 - 1.39	1.04 - 1.18	0.84 - 0.95	0.56 - 0.63	3.5	0.875
1.40 - 1.56	1.19 - 1.33	0.96 - 1.07	0.64 - 0.71	4.0	1.000
1.57 - 1.74	1.34 - 1.48	1.08 - 1.19	0.72 - 0.78	4.5	1.125
1.75 - 1.91	1.49 - 1.63	1.20 - 1.31	0.79 - 0.86	5.0	1.250
1.92 - 2.09	1.64 - 1.78	1.32 - 1.43	0.87 - 0.94	5.5	1.375
2.10 - 2.26	1.79 - 1.93	1.44 - 1.55	0.95 - 1.02	6.0	1.500
2.27 - 2.44	1.94 - 2.08	1.56 - 1.67	1.03 - 1.10	6.5	1.625
2.45 - 2.61	2.09 - 2.23	1.68 - 1.79	1.11 - 1.18	7.0	1.750
2.62 - 2.79	2.24 - 2.38	1.80 - 1.91	1.19 - 1.26	7.5	1.875
Higher than 2.80	Higher than 2.39	Higher than 1.92	Higher than 1.27	8.0	2.000

If the lung function parameter IC is available refer to the following table to select an inhalation volume (or inhalation time per breath).

Inspiratory Capacity (IC) in [l]	Inhalation time per breath [s]	Inhalation Volume (IV) in [l]
0.00 - 0.37	No setting available	
0.38 - 0.57	1.0	0.250
0.58 - 0.75	1.5	0.375
0.76 - 0.95	2.0	0.500
0.96 - 1.14	2.5	0.625
1.15 - 1.34	3.0	0.750
1.35 - 1.53	3.5	0.875
1.54 - 1.72	4.0	1.000
1.73 - 1.91	4.5	1.125
1.92 - 2.11	5.0	1.250
2.12 - 2.30	5.5	1.375
2.31 - 2.49	6.0	1.500
2.50 - 2.68	6.5	1.625
2.69 - 2.87	7.0	1.750
2.88 - 3.09	7.5	1.875
Higher than 3.10	8.0	2.000

11 Warranty









During the warranty period Vectura will compensate for any defects resulting from faults in material or manufacturing free of charge. The owner shall not be entitled to cancel the sale or demand a partial or full refund of the purchase price.













Damage resulting from improper use of the device is not covered by this warranty. The warranty becomes void if repairs are carried out on the device by unauthorized persons. Compensation for direct or indirect damage or injury is excluded from the warranty.

Should you have a complaint, please email it to fox.mobile@vectura.com.

The warranty period for the FOX MOBILE Base Unit is 2 years from the date of purchase.

12 Explanation of Symbols used

Symbol	Indication
	This device complies with the requirements of the Medical Devices Directive (93/42/EEC)
	Follow Instructions For Use!
	This device is a protection class II appliance
	This device is a Type BF equipment
IP22	Ingress protection, see chapter 9.1
FC	This device complies with part 15 of the FCC Rules. Operation is subject to the following two conditions: <ol style="list-style-type: none"> 1. This device may not cause harmful interference, and 2. This device must accept any interference received, including interference that may cause undesired operation.
	This product is compliant with WEEE recycling directives (Directive 2002/95/EC).
	This device contains a Bluetooth module Transmitter Module FCC ID: QOQWT12
	Temperature range
	Store and use in dry conditions
	Do not store in direct solar radiation

	Legal manufacturer
	Year of manufacture
	Device emitting non-ionizing radiation
	Use-by date
	ON/OFF button
	Battery status display
	Reference number (article number)
	Serial number
	Medical device
	Unique device identifier
	Indicates a medical device that may be used multiple times (multiple procedures) on a single patient
	Direct current
Rx only	Prescription only

We reserve the right to make technical changes.
Information as of March 2026

